

ABS FRAME Motorized Brackets RUN 800mm

They allow an immediate setting of the photocell height according to the installed punch.
Manageable through CNC and barcode scanner reading device.

- Immediate adjustment
- Great range of movement
- Suitable for any type of machine





TRIVENETA SISTEMI

ABS Motorized Brackets

COD. 004 800

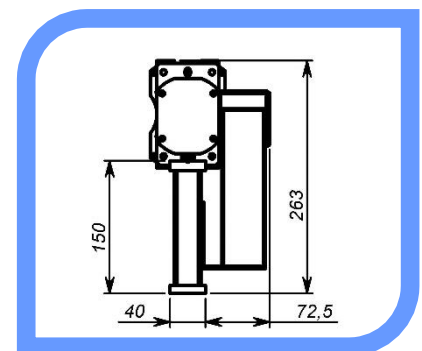
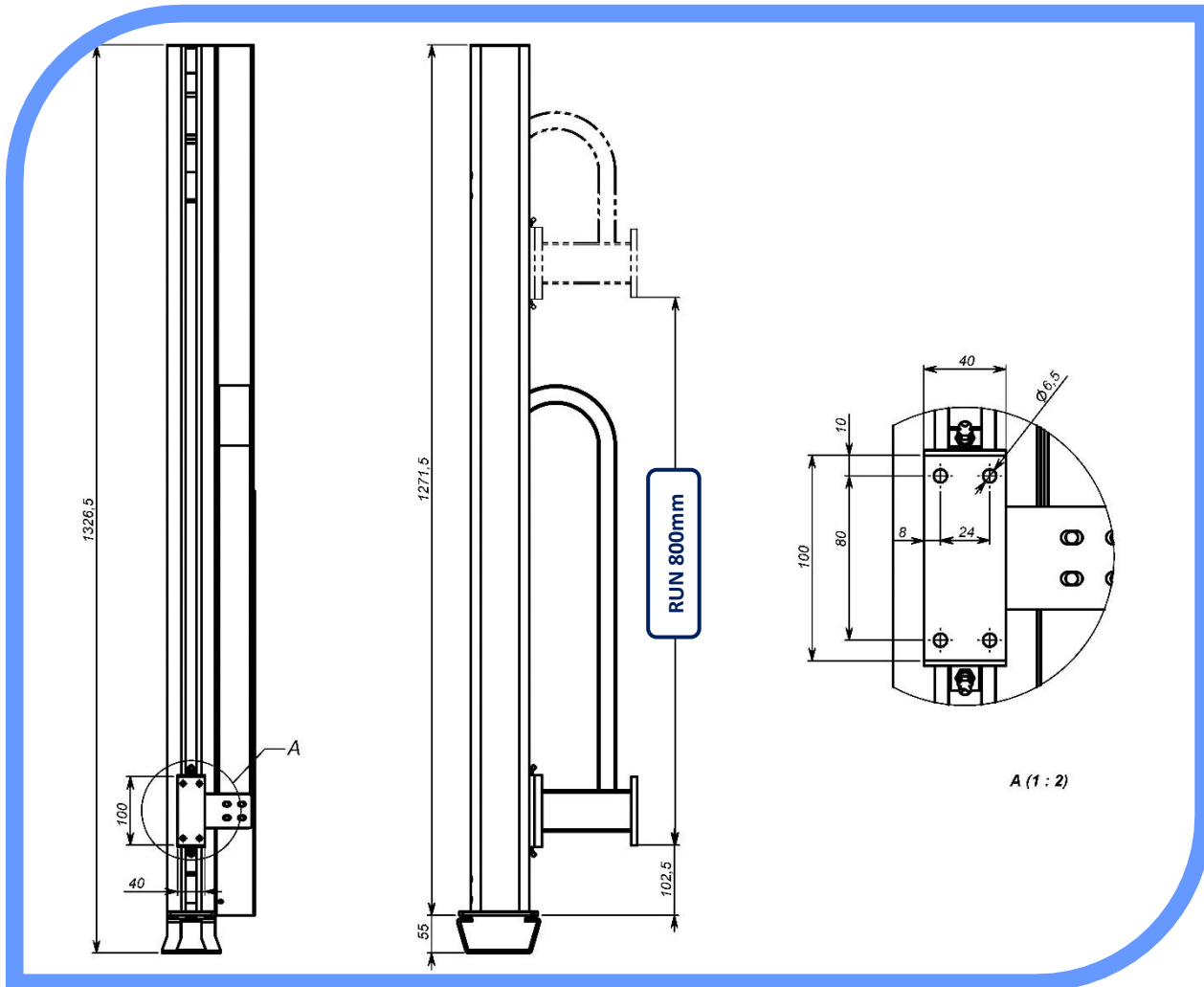

TRIVENETA IMPIANTI S.r.l.

Administrative Headquarters: Via Scopella, 22 - 37060 Castel d'Azzano VR - Italy

Operational Headquarters: Via Bovolino, 18/B - 37060 Buttapietra VR - Italy

Phone: +39 045 518 747 - Fax +39 045 854 56 05 - Web Site: www.trivenetaimpianti.com - E-mail: sales@trivenetaimpianti.com